



# YAMAHA CDM-900

*110-Disc CD Changer*

COMPACT  
**disc**  
DIGITAL AUDIO

## OWNER'S MANUAL

### FEATURES

- 110-Disc Auto-changer
- Random Access Programmable Play
- Random-Sequence Play
- Single Track/Entire Disc/All Discs Repeat Play
- Album/Artist Name Filing Capability
- Favorite Tracks on Each Disc Filing Capability
- 220-Disc Relay Play by Connecting Two CDM-900s
- Group Play
- CD TEXT Compatibility
- Disc Search Using CD TEXT
- Index Search
- Full Operation Remote Control
- Optical Digital Output
- Timer Play Option

## CONTENTS

Safety Instructions .....	2
Connections .....	4
Identification of Components .....	5
Inserting CDs .....	7
Basic Operation .....	8
Random-Sequence Play .....	11
Repeat Play .....	12
Program Play .....	13
Group play .....	15
Index Search .....	17
Intro scan .....	17
Disc filing .....	18
Relay play .....	21
Timer play .....	22
Notes about the Remote Control Transmitter .....	23
CD Preventive Care .....	23
Troubleshooting .....	24
Specifications .....	25

# SAFETY INSTRUCTIONS

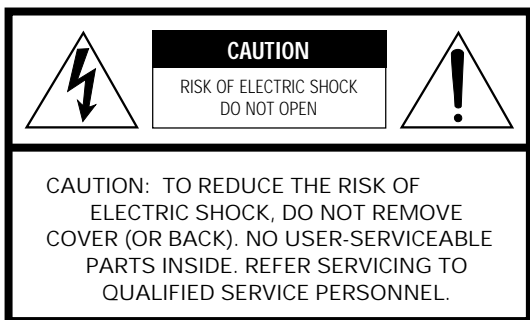

• Explanation of Graphical Symbols

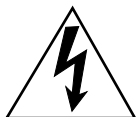

The lightning flash with arrowhead symbol, within an equilateral triangle, is intended to alert you to the presence of uninsulated "dangerous voltage" within the product's enclosure that may be of sufficient magnitude to constitute a risk of electric shock to persons.



The exclamation point within an equilateral triangle is intended to alert you to the presence of important operating and maintenance (servicing) instructions in the literature accompanying the appliance.



- 1 Read Instructions – All the safety and operating instructions should be read before the unit is operated.
- 2 Retain Instructions – The safety and operating instructions should be retained for future reference.
- 3 Heed Warnings – All warnings on the unit and in the operating instructions should be adhered to.
- 4 Follow Instructions – All operating and other instructions should be followed.
- 5 Water and Moisture – The unit should not be used near water – for example, near a bathtub, washbowl, kitchen sink, laundry tub, in a wet basement, or near a swimming pool, etc.
- 6 Carts and Stands – The unit should be used only with a cart or stand that is recommended by the manufacturer.
- 6A A unit and cart combination should be moved with care. Quick stops, excessive force, and uneven surfaces may cause the unit and cart combination to overturn.
- 7 Wall or Ceiling Mounting – The unit should be mounted to a wall or ceiling only as recommended by the manufacturer.
- 8 Ventilation – The unit should be situated so that its location or position does not interfere with its proper ventilation. For example, the unit should not be situated on a bed, sofa, rug, or similar surface, that may block the ventilation openings; or placed in a built-in installation, such as a bookcase or cabinet that may impede the flow of air through the ventilation openings.
- 9 Heat – The unit should be situated away from heat sources such as radiators, stoves, or other appliances that produce heat.



- 10 Power Sources – The unit should be connected to a power supply only of the type described in the operating instructions or as marked on the unit.
- 11 Power-Cord Protection – Power-supply cords should be routed so that they are not likely to be walked on or pinched by items placed upon or against them, paying particular attention to cords at plugs, convenience receptacles, and the point where they exit from the unit.
- 12 Cleaning – The unit should be cleaned only as recommended by the manufacturer.
- 13 Nonuse Periods – The power cord of the unit should be unplugged from the outlet when left unused for a long period of time.
- 14 Object and Liquid Entry – Care should be taken so that objects do not fall into and liquids are not spilled into the inside of the unit.
- 15 Damage Requiring Service – The unit should be serviced by qualified service personnel when:
  - A. The power-supply cord or the plug has been damaged; or
  - B. Objects have fallen, or liquid has been spilled into the unit; or
  - C. The unit has been exposed to rain; or
  - D. The unit does not appear to operate normally or exhibits a marked change in performance; or
  - E. The unit has been dropped, or the cabinet damaged.
- 16 Servicing – The user should not attempt to service the unit beyond those means described in the operating instructions. All other servicing should be referred to qualified service personnel.
- 17 Power Lines – An outdoor antenna should be located away from power lines.
- 18 Grounding or Polarization – Precautions should be taken so that the grounding or polarization is not defeated.

## We Want You Listening For A Lifetime

YAMAHA and the Electronic Industries Association's Consumer Electronics Group want you to get the most out of your equipment by playing it at a safe level. One that lets the sound come through loud and clear without annoying blaring or distortion – and, most importantly, without affecting your sensitive hearing. Since hearing damage from loud sounds is often undetectable until it is too late, YAMAHA and the Electronic Industries Association's Consumer Electronics Group recommend you to avoid prolonged exposure from excessive volume levels.



### IMPORTANT!

Please record the serial number of this unit in the space below.

Model:  
Serial No.:

The serial number is located on the rear of the unit. Retain this Owner's Manual in a safe place for future reference.

## CAUTION: READ THIS BEFORE OPERATING YOUR UNIT

- 1 To ensure the finest performance, please read this manual carefully. Keep it in a safe place for future reference.
- 2 Install your unit in a cool, dry, clean place, and in a horizontal and stable position – away from windows, heat sources, vibration, dust, moisture, or cold. To avoid humming sounds, locate the unit away from other electrical appliances, motors, and transformers. To prevent fire or electrical shock, do not expose to rain and water.
- 3 Do not operate the unit upside-down. It may overheat, possibly causing damage.
- 4 Do not put anything other than discs in the unit. If any foreign object should fall into the unit, contact your dealer.
- 5 Do not use force on switches, knobs or cords.
- 6 Do not clean the unit with chemical solvents; this might damage the finish. Use a clean, dry cloth.
- 7 Be sure to read the “TROUBLESHOOTING” section on common operating errors before concluding that your unit is faulty.
- 8 Do not place another component on top of this unit, as damage or discoloration on the surface of the unit may result.
- 9 To prevent damage by lightning, disconnect the power cord from the AC outlet during an electrical storm.
- 10 When disconnecting the power cord from the AC outlet, grasp the plug; do not pull the cord.

This unit is not disconnected from the AC power source as long as it is connected to the wall outlet, even if this unit itself is turned off. This state is called the standby mode. In this state, this unit is designed to consume a very small quantity of power.

### CAUTION FOR CARRYING THIS UNIT

When you carry the unit:

- 1 Press **STANDBY/ON** and make sure “**STANDBY**” disappears from the display.
- 2 Remove all CDs from the unit.
- 3 Disconnect the power cord from the AC outlet.

## WARNING

### CAUTION

Use of controls or adjustments or performance of procedures other than those specified herein may result in hazardous radiation exposure.

### DANGER

Invisible laser radiation when open and interlock failed or defeated.  
Avoid direct exposure to beam.

### CAUTION (FOR CANADA MODEL)

TO PREVENT ELECTRIC SHOCK, MATCH WIDE BLADE OF PLUG TO WIDE SLOT AND FULLY INSERT.

### FOR CANADIAN CUSTOMER

THIS CLASS B DIGITAL APPARATUS MEETS ALL REQUIREMENTS OF THE CANADIAN INTERFERENCE-CAUSING EQUIPMENT REGULATIONS.

As the laser beam used in this compact disc player is harmful to the eyes, do not attempt to disassemble the cabinet. Refer servicing to qualified personnel only.

To avoid electrical shock, do not open the unit. Refer servicing to qualified personnel only.

**DANGER:** The use of optical instrument with this product will increase eye hazard.

### Laser Diode Properties

- Material: GaAlAs
- Wavelength: 780 nm
- Emission Duration: continuous
- Laser Output: max. 44.6  $\mu$ W\*

\* This output is the value measured at a distance of about 200 mm from the objective lens surface on the Optical Pick-up Block.

## FCC INFORMATION (for US customers only)

### 1. IMPORTANT NOTICE: DO NOT MODIFY THIS UNIT!

This product, when installed as indicated in the instructions contained in this manual, meets FCC requirements. Modifications not expressly approved by Yamaha may void your authority, granted by the FCC, to use the product.

2. **IMPORTANT:** When connecting this product to accessories and/or another product use only high quality shielded cables. Cable/s supplied with this product **MUST** be used. Follow all installation instructions. Failure to follow instructions could void your FCC authorization to use this product in the USA.

3. **NOTE:** This product has been tested and found to comply with the requirements listed in FCC Regulations, Part 15 for Class “B” digital devices. Compliance with these requirements provides a reasonable level of assurance that your use of this product in a residential environment will not result in harmful interference with other electronic devices.

This equipment generates/uses radio frequencies and, if not installed and used according to the instructions found in the users manual, may cause interference harmful to the operation of other electronic devices.

Compliance with FCC regulations does not guarantee that interference will not occur in all installations. If this product is found to be the source of interference, which can be determined by turning the unit “OFF” and “ON”, please try to eliminate the problem by using one of the following measures:

Relocate either this product or the device that is being affected by the interference.

Utilize power outlets that are on different branch (circuit breaker or fuse) circuits or install AC line filter/s.

In the case of radio or TV interference, relocate/reorient the antenna. If the antenna lead-in is 300 ohm ribbon lead, change the lead-in to coaxial type cable.

If these corrective measures do not produce satisfactory results, please contact the local retailer authorized to distribute this type of product. If you can not locate the appropriate retailer, please contact Yamaha Electronics Corp., U.S.A. 6660 Orangethorpe Ave, Buena Park, CA 90620.

The above statements apply **ONLY** to those products distributed by Yamaha Corporation of America or its subsidiaries.

# CONNECTIONS

- **Never plug in this unit or other components until all connections are completed.**
- Connections should be made to the correct input terminals of the amplifier or other components.
- To connect another unit for relay play, see page 21.
- If the placement of this unit creates interference (noise) in other equipment, such as a tuner, relocate this unit away from the affected equipment.

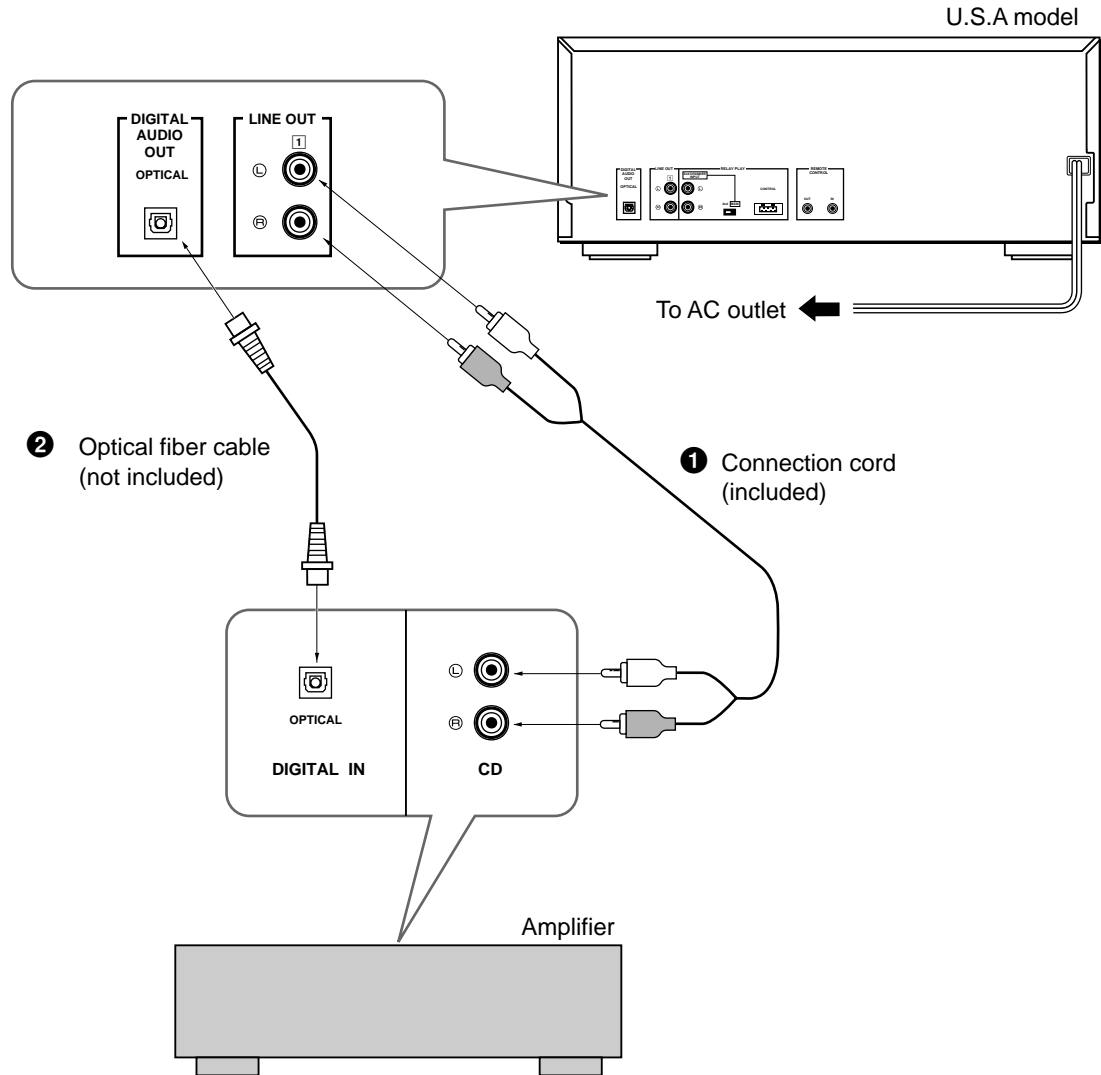

To connect this unit to your amplifier, choose one of the following procedures:

## 1 When the LINE OUT (analog) terminals of this unit are used

- Be sure that the left ("L") and right ("R") LINE OUT terminals are connected to the corresponding (left and right) terminals of the amplifier or other component.
- Connect the "LINE OUT" terminals to the "CD" (or "AUX") terminals of the amplifier. If the amplifier does not have such terminals, use the "TAPE PB" terminals. For additional details concerning these connections, refer to the operation instructions of the amplifier being used.
- The LINE OUT terminals of this unit are numbered **1**. When connecting this unit with a YAMAHA amplifier or receiver whose terminals on the rear panel are numbered as **1**, **2**, **3**, etc., connect the LINE OUT terminals of this unit to the input terminals numbered **1** on the rear panel of the amplifier or receiver.

## 2 When the DIGITAL OUT terminal of this unit is used

- This unit has a DIGITAL OUT (OPTICAL) terminal on the rear panel.
- Before using the terminal on the rear panel, remove the terminal's cover.
  - Make the connection from the terminal to the optical input terminal of an amplifier or other digital audio component by using a commercially available optical fiber cable.
    - \* Use an optical fiber cable that conforms to EIAJ standards. Other cables might not function correctly.
  - Be sure to replace the terminal's cover when the terminal on the rear panel is not being used, in order to protect from dust.
  - The terminal can also be connected to the optical input terminal of a DAT (Digital Audio Tape) deck or MD (Mini Disc) deck, etc., to record a CD directly.
  - The output level of this terminal is not variable.

# IDENTIFICATION OF COMPONENTS

## REMOTE CONTROL TRANSMITTER

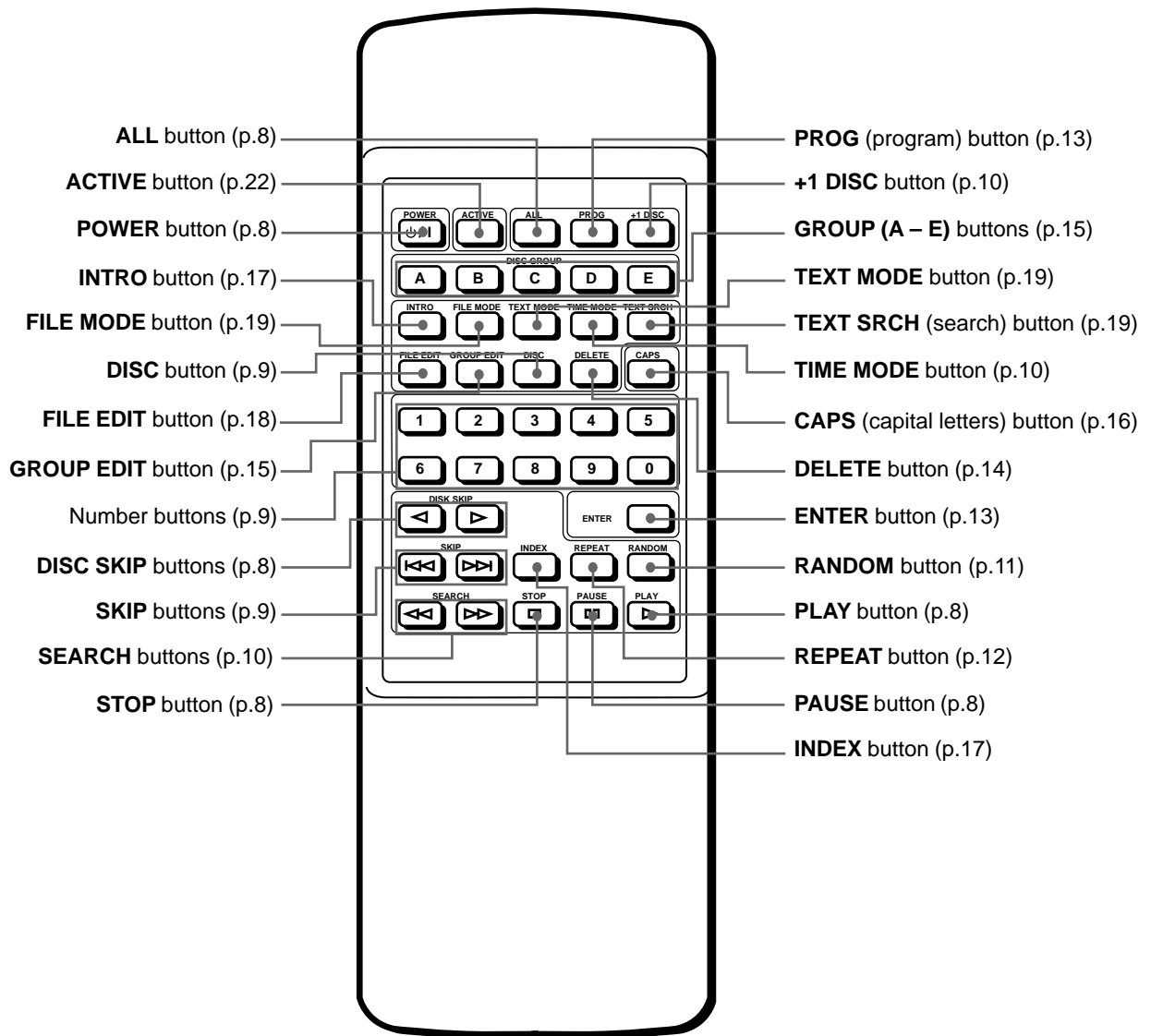

\* This manual describes how to operate this unit by using the remote control transmitter. To operate this unit from the front panel, use the corresponding buttons on the front panel (see page 6).

## *For Custom Installer*

### **For U.S.A., Canada and Australia models only**

#### **REMOTE CONTROL (IN, OUT) terminals**

These terminals are used for custom installation system. When this unit is connected to the components for custom installation system, you can operate this unit with the system remote control.

Connect the **REMOTE CONTROL IN** terminal of this unit to the output terminal of the central controller for custom installation system.

By connection the **REMOTE CONTROL OUT** terminal of this unit to the REMOTE CONTROL IN terminal of the other component, you can also operate the component with the system remote control. In this way, up to 6 components can be connected in series.

# FRONT PANEL

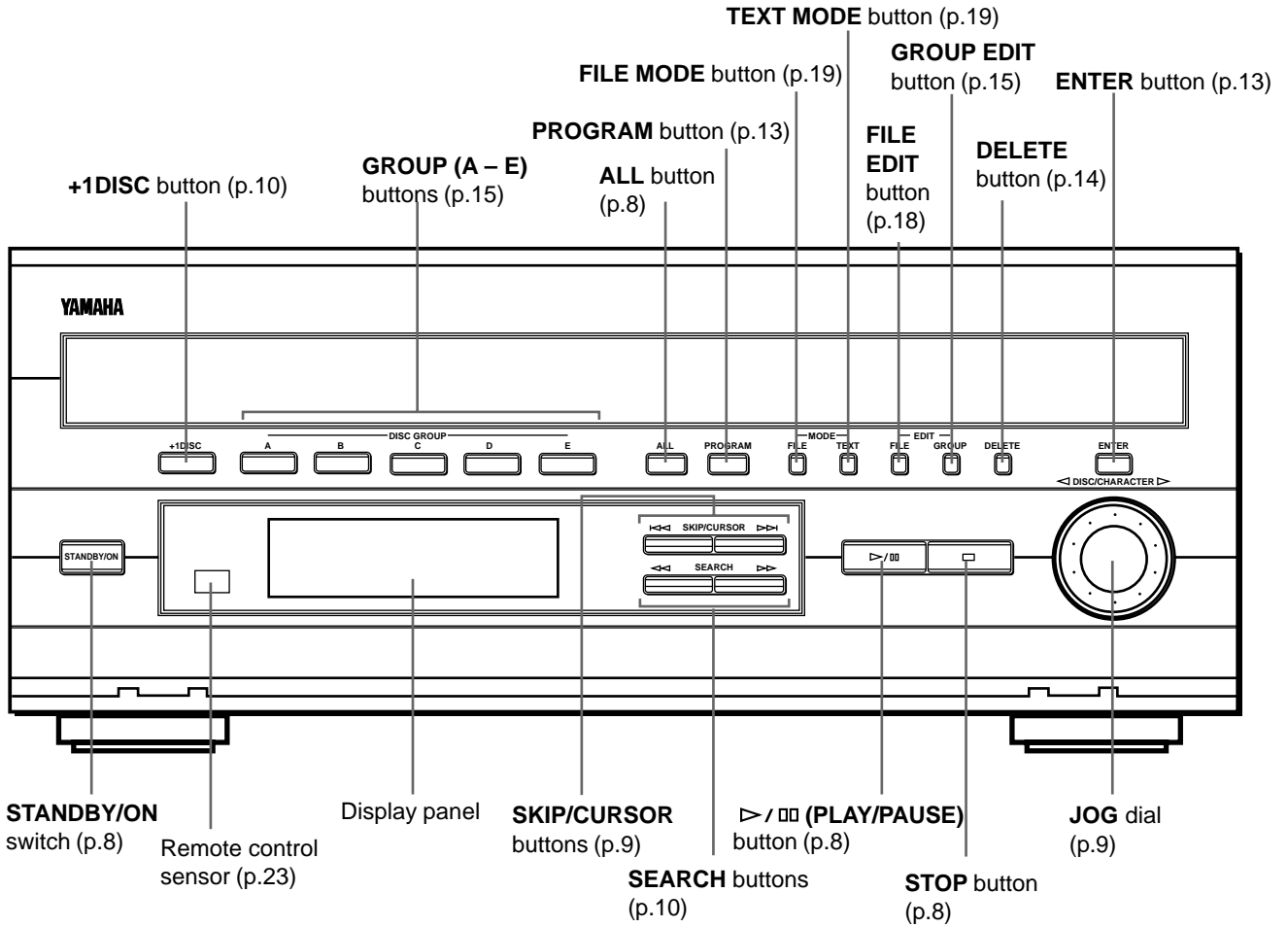

\* The **PLAY/PAUSE** button on the front panel has the functions of both the **PLAY** button and the **PAUSE** button on the remote control transmitter.

# DISC SLOT SECTION

For an explanation on how to open the front panel, see page 7.

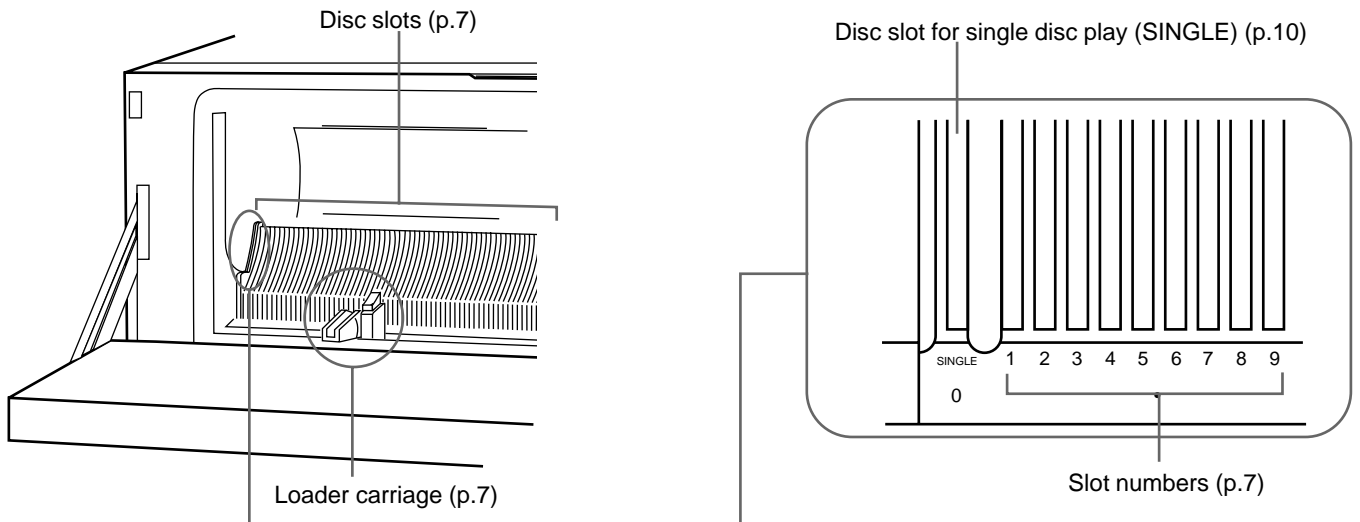

# INSERTING CDS

- 1 Open the front panel, by pulling gently from both ends.

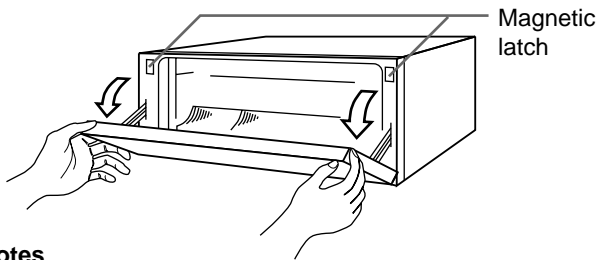

## Notes

- Except when inserting or removing discs, keep your hands out of the unit while the front panel is open. You could be injured if your hands could become entangled in the internal mechanism.
- Keep cassette tapes, video cassettes, or floppy discs away from the magnetic latches.

- 2 Slide the loader carriage to the desired slot number to insert a disc.

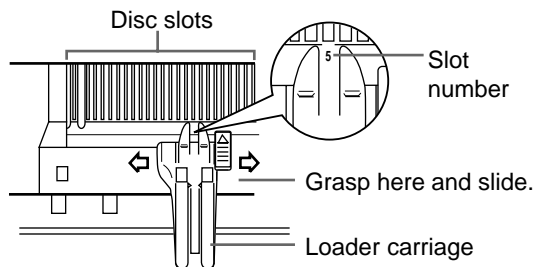

Slot No. 0 (SINGLE) is reserved for single disc play mode.

- 3 Set the disc on the loader and flip the loader upwards.

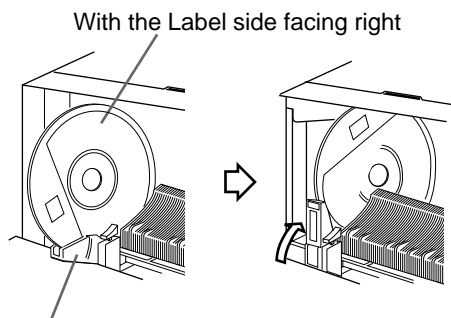

Flip this part upward.

## Notes

- Do not use 8-cm (3-inch) CDs. Even if you use the expander rings, the unit could be damaged.
- Do not put anything other than discs in the unit.

- 4 Close the front panel gently.

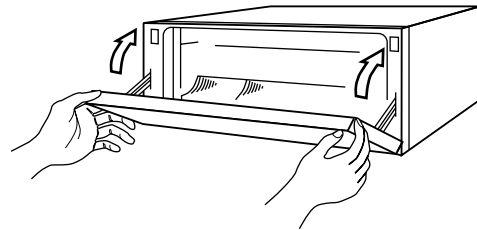

## Note

- If you leave the front panel open while a disc is in play, when the disc is over, the unit will stop.

## To remove discs

- 1 Open the front panel.

- 2 Slide the loader carriage to the slot of the disc you want to remove.

- 3 Press the eject button on the loader carriage.

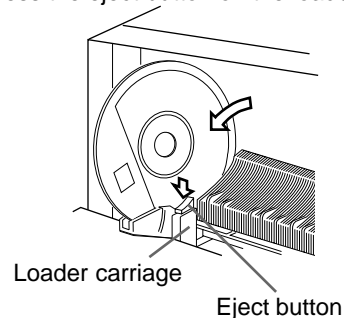

## CAUTION FOR CARRYING THIS UNIT

When you carry the unit:

- 1 Press **STANDBY/ON** and make sure "STANDBY" disappears from the display.
- 2 Remove all CDs from the unit.
- 3 Disconnect the power cord from the AC outlet.

## Notes

- You can insert and remove discs while playing a disc.
  - Do not set a disc in the slot of the disc being played (slot indicator flashes). The disc in play is returned to its slot when finished. If there is a disc in the slot of the disc at play, when the disc is finished, "TAKE OUT" appears in the display. Remove the disc from the currently playing disc's slot.
  - Sometimes the front panel cannot be opened while a disc is playing. In such case, wait a few moments or until the disc stops playing then try again.
- Insert the CD correctly and avoid abrupt eject button operation to prevent discs from popping out or falling into the unit during operation.

# BASIC OPERATION

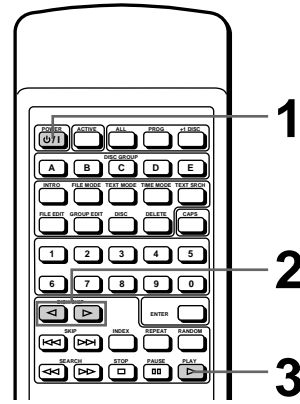
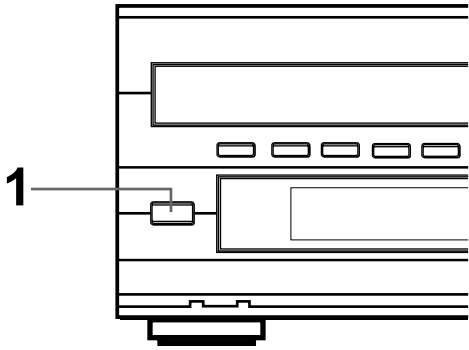

**1** Turn the power on.

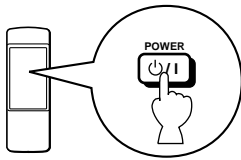

“DISC LOADING” appears in the display for a few seconds. Then, the disc number that was played most recently appears in the display.

**2** Press **DISC SKIP** repeatedly until the desired disc number appears in the display.

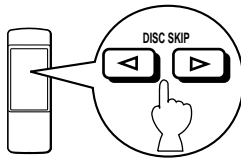

**3**

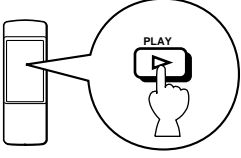

The unit plays all discs in the unit from the selected one.

## To stop play temporarily

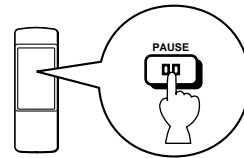

To resume play, press **PAUSE** again (or press **PLAY**).  
\* The  $\triangleright/\square$  button on the front panel can also be used to stop play temporarily or to resume play.

## To stop play completely

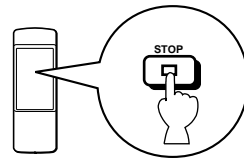

**To turn off the unit (standby mode)**  
Press **POWER** again.

### Note

- To play all the discs in the unit, make sure the “ALL” indicator appears in the display. If not, press **ALL**. In ALL play mode, the unit plays all the discs from the selected one. Empty disc slots are skipped.

## Display information during disc play

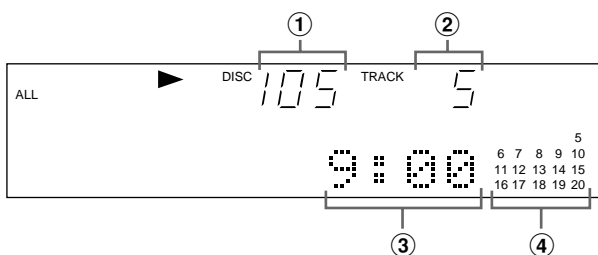

- Shows the disc number selected or being played.
- Shows the track number selected or being played.
- Shows the time. (Refer to “Selecting time displays” on page 10.)
- Shows the CD track numbers (up to 20). After each track is played, its corresponding number disappears so that remaining track numbers can be seen at a glance.



## To play a specific disc

- 1 Press **DISC** and the number button of the desired disc.

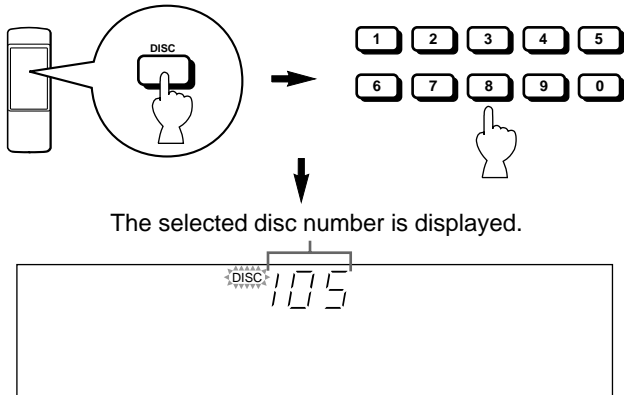

You can also select the disc with the JOG dial on the front panel. In this case, turn the JOG dial on the front panel until the desired disc number appears in the display.

- 2 Press **▶** to start play.

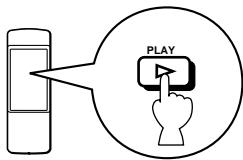

**Example:** To select disc 105, press 1, then 0, then 5.

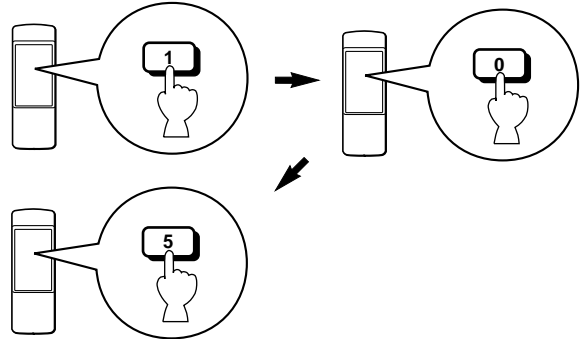

### Note

- If there is no disc in the slot you select, the unit plays the disc in the next slot up which contains a disc.

## To play a specific track on the disc

### DIRECT PLAY

- 1 Select a desired track using the number buttons.

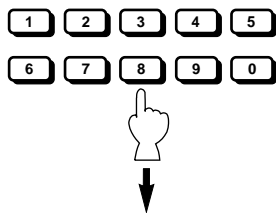

The selected track number is displayed.

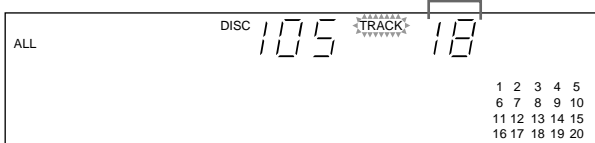

- 2 Press **▶** to start play.

**Example:** To select track 25, press 2, then 5.

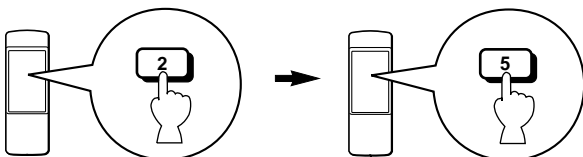

### SKIP PLAY

To skip to a succeeding track, press **SKIP ▶▶** once or repeatedly until the desired track number appears.

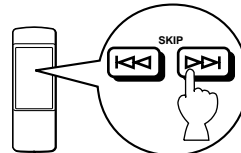

To skip to the beginning of the current track, press **SKIP ◀◀** once.

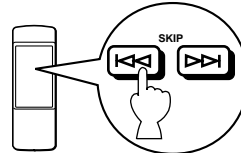

To skip to a preceding track, press **SKIP ◀◀** repeatedly until the desired track number appears.

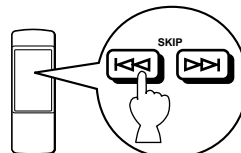

### Notes

- These operations can also be performed when the unit is in the pause or stop mode.
- If **SKIP** is pressed and held, the track number successively changes to higher numbers (or lower numbers).

\* If you enter a number that is higher than the last track number on the disc, the final track is played.

## To advance or reverse play rapidly (MANUAL SEARCH)

### To advance rapidly



### To reverse rapidly

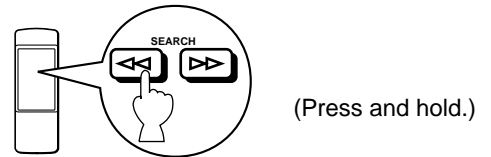

- The sound can be heard (although slightly garbled) during manual search in either direction. This is convenient for locating a precise position within a track, or for reviewing the contents quickly.
- Manual search can also be performed while disc play is paused, though no sound will be heard.

## Selecting time displays

You can select any of the four time displays by pressing **TIME MODE**. Each time you press **TIME MODE**, the display changes as follows:

### ① Elapsed time of the track now playing

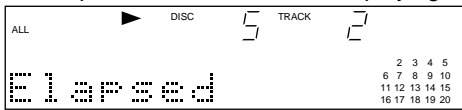

↓ after 2 seconds

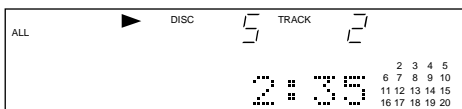

### ④ Total remaining time on the disc

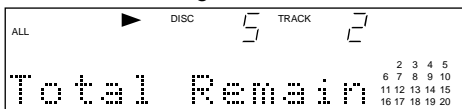

↓ after 2 seconds

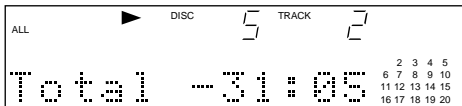

### ② Remaining time of the track now playing

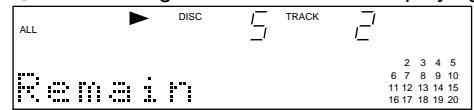

↓ after 2 seconds

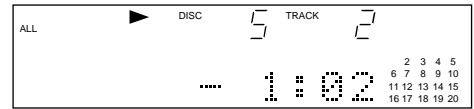

### ③ Total disc play time

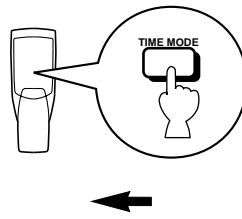
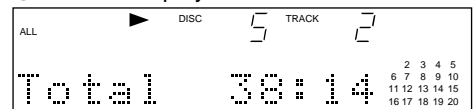

## SINGLE DISC PLAY

You can use the unit as a single CD player by using slot number 0 (SINGLE).

**1** Insert a disc into slot number 0 (SINGLE) (see page 7).

**2** Press **+1 DISC** so that "+1" appears in the display.

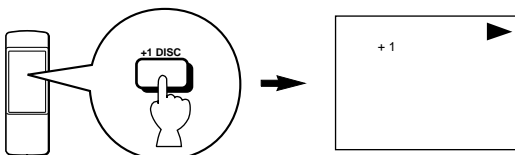

**3**

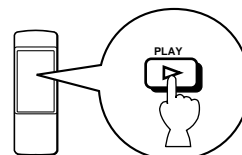

The unit stops automatically after finishing all the tracks of the disc in slot number 0.

### Notes

- You can enjoy random-sequence play (see page 11) or repeat play (see page 12) in this mode.
- When you press **ALL** or **GROUP (A – E)** during single disc play mode, single disc play mode will be cancelled.

# RANDOM-SEQUENCE PLAY

The unit can play all the tracks on a selected disc or on all discs in a random sequence selected by the unit's microcomputer.

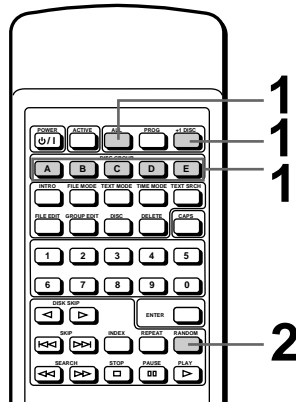

**1** Press **+1 DISC**, **ALL**, or **GROUP** (see "GROUP PLAY" on page 15) to select the playing mode.

**2** Press **RANDOM**.

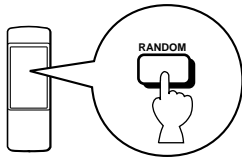

The mode indicator you select appears

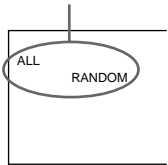

RANDOM appears in the display.

## +1 DISC MODE

The unit plays all tracks on the current disc in random order.

## ALL MODE

The unit plays all tracks on all discs in random order.

## GROUP MODE

The unit plays all tracks on all the discs of the selected group in random order.

## To cancel random-sequence play mode

Press **STOP** or **RANDOM**.

"RANDOM" disappears from the display.

## Notes

- This feature will not function during programming, or during programmed play.
- If **SKIP**  $\triangleright\triangleright$  is pressed during random-sequence play, the next randomly programmed track will be played. If **SKIP**  $\triangleleft\triangleleft$  is pressed, play will return to the beginning of the current track.
- Total remaining time on the disc will not be displayed during random-sequence play.

# REPEAT PLAY

You can play any desired track or disc, or all discs repeatedly.

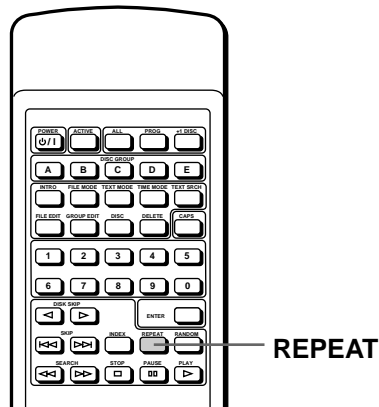

Press **REPEAT** to select the repeat mode.

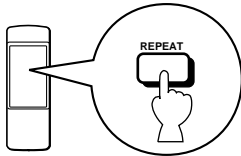

Each time you press **REPEAT**, the display changes as follows:

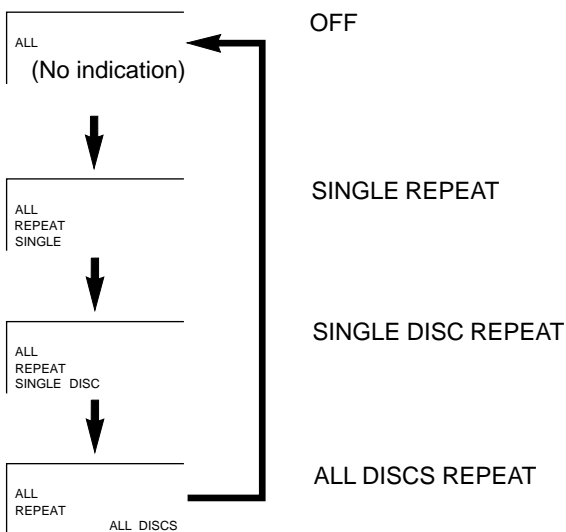

## SINGLE REPEAT

The current track is played repeatedly.

## SINGLE DISC REPEAT

The current disc is played repeatedly.

- \* In the random-sequence play mode, all randomly sequenced tracks are played repeatedly in the same order.
- \* In the programmed-play mode, SINGLE DISC REPEAT play is not available.

## ALL DISCS REPEAT

All tracks on all discs are played repeatedly.

- \* In the programmed-play mode, all programmed tracks are played repeatedly.
- \* In the group play mode, all tracks on all discs in the group you selected are played repeatedly.
- \* In the random-sequence play mode, all randomly sequenced tracks on all discs are played repeatedly.
- \* In the +1 DISC mode, ALL DISCS REPEAT play is not available.

## To cancel repeat play mode

Press **REPEAT** successively until "REPEAT" disappears from the display.

## Note

- When you turn the unit off during SINGLE DISC REPEAT or ALL DISCS REPEAT play mode, the next time you turn the unit on, the play mode will be restored.

# PROGRAM PLAY

By creating a program, you can enjoy listening to your favorite discs or tracks in any desired order. As many as 40 steps can be programmed in sequence.

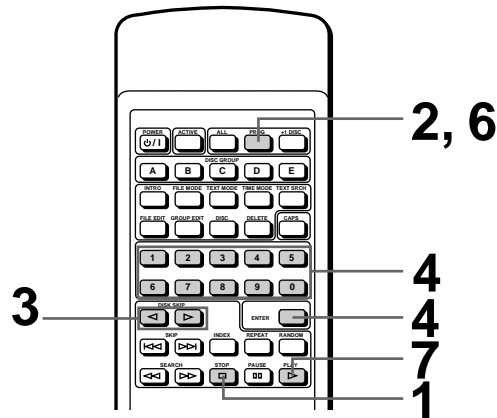

**1** Stop the unit.

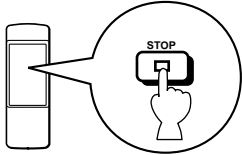

**2** Press **PROG**.

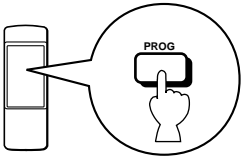

**3** Press **DISC SKIP** to select the disc number you want to program.

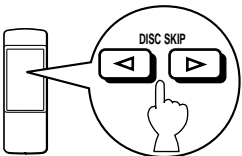

**4** Press the number button of the desired track, then press **ENTER**.

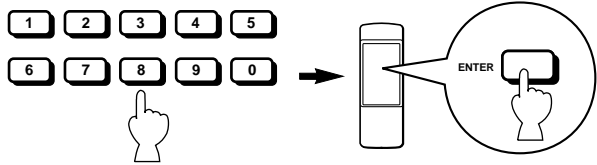

\* You can program an entire disc as one step by pressing 0 ("AL" flashes in the display).

**5** Repeat steps 3 to 4 to program more discs and tracks. You can select the same disc or track again.

**6** Press **PROG** to exit the program input mode.

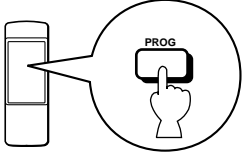

**7**

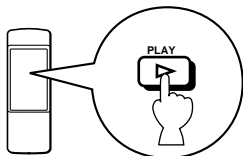

## Display information during programming

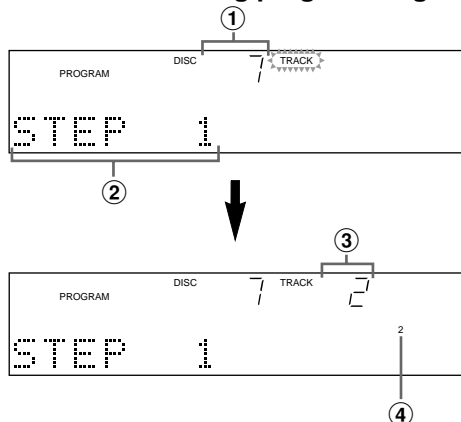

- ① Shows the selected disc number.
- ② Shows the program number for the track to be entered next.
- ③ Shows the selected track number.
- ④ Shows the numbers of programmed tracks.

## Notes

- When you change to program play mode from another play mode, press **STOP** and **PROG** ("PROG" appears in the display), then press **PLAY** to start program play.
- To select a disc directly, press **DISC**, the number button of the desired disc and **ENTER**, or turn the JOG dial on the front panel in step 3 of the previous page.
- **SKIP** (  $\lll$  and  $\ggg$  ) can be used during program play to skip to tracks within the program.
- **SEARCH** (  $\lll$  and  $\ggg$  ) can be used during program play to search all tracks, including unprogrammed tracks.
- Even if you press **POWER** to turn the unit off, the programs you have set remain in the unit's memory.
- If you program a track that is not included in a disc, "ERROR" appears in the display.
- If you program an entire disc as one step, "1" appears in the display during program play.

---

## To cancel program play mode

Press **ALL**, **+1 DISC**, or **GROUP (A – E)** during program play mode. Program play mode will be canceled.

## To check program data

1. Press **STOP** to stop program play.
2. Press **PROG**.
3. Press **SKIP**  $\ggg$  . Each time you press this button, the disc and track number and the program number are displayed in the order of the program. When you want to check the preceding disc or tracks, press **SKIP**  $\lll$  .

### Note

- When you program an entire disc as one step, "AL" appears in the display when you press **SKIP** to check program data.

## To change program data

1. Follow the preceding procedure described in "To check program data."
2. Display the disc or track number to be deleted or corrected by pressing **SKIP**.
3. Press **DISC SKIP** to select the desired disc and press the number button of the desired track you want to substitute for the one currently displayed.  
( When you want to program an entire disc as one step, press 0 after pressing **DISC SKIP**.)
4. Press **ENTER**.  
The previously programmed track or disc will be cleared from the memory and the new one will be programmed. If you want to delete the programmed track or disc currently displayed, press **DELETE** before pressing **ENTER**.
5. When you are finished, press **PROG** or **PLAY**.

### Note

- When you program an entire disc as one step, "AL" appears in the display when you press **SKIP** to change program data.

## To delete all program data

1. Follow of steps 1 and 2 of the procedure described in "To check program data."
2. Press and hold **DELETE** for more than 5 seconds.
3. "DELETE" appears for a moment, then "ALL DELETE" appears and the entire contents of memory is deleted.

# GROUP PLAY

You can create and name up to 5 groups in which to categorize discs according to your preference (artists, music type, etc.) and enjoy any play mode within each group.

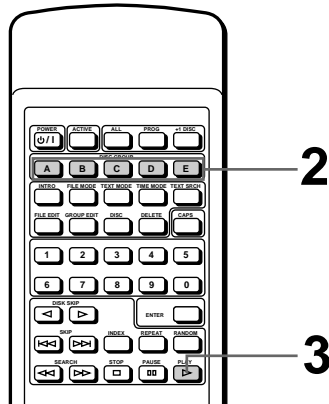

**1** Insert discs into the slots of the group you want to create (see page 7). The pre-installed border numbers between each group are:

- Group A, from 1 to 20
- Group B, from 21 to 40
- Group C, from 41 to 60
- Group D, from 61 to 80
- Group E, from 81 to 110.

\* You can change these border numbers (see this page).

**2** Press **GROUP (A – E)** to select the group you want to play.

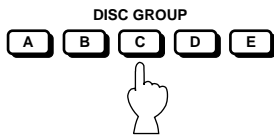

The selected group appears in the display.

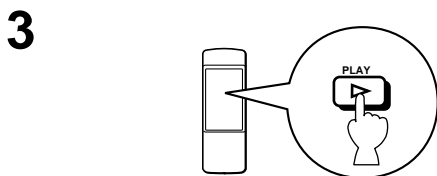

The unit automatically stops after playing the last disc in the group.

## To cancel group play mode

Press **ALL** or **+1 DISC** during group play mode. Group play mode will be canceled.

## To change a border number

1. During stop, press **GROUP EDIT**.
2. Press **GROUP (A – E)** to select the group you want to change.
3. Press **SKIP**  $\lll$  or  $\ggg$  to select the border you want to change. Selected border numbers flash in the display.
4. Press **DISC SKIP** or turn the JOG dial on the front panel to select the new border number. The border number of any group adjacent to the border number you changed will also be changed.
5. Press **GROUP EDIT** twice.

## Notes

- Each group must have a at least one disc.
- You can enjoy random-sequence or repeat play within a certain group.

## Display information during group edit (bordering)

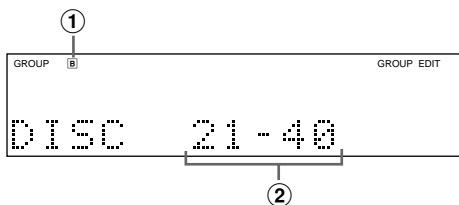

- ① Shows the selected group.
- ② Shows the border numbers of the selected group.

## To edit the group name

1. During stop, press **GROUP EDIT**.
2. Press **GROUP (A – E)** to select the group you want to edit.
3. Press **GROUP EDIT**.  
The group name appears in the display.  
(The pre-installed group names are GROUP A, GROUP B, GROUP C, GROUP D, and GROUP E.)
4. Press **SKIP** to select the cursor position you want to edit.
5. Press **DELETE** to delete the character, or press **SEARCH** or turn the JOG dial on the front panel to select the character you want.
6. Repeat steps 4 and 5 until all the characters you want are input.
7. Press **GROUP EDIT** to store the group name.

## To delete the group name

1. Follow of steps 1, 2, and 3 above.
2. Press **SKIP** to move the cursor to first character.
3. Press **DELETE** repeatedly until all the characters disappear.

## Notes

- When you input a character, each time you press **CAPS**, the type of character changes as follows.

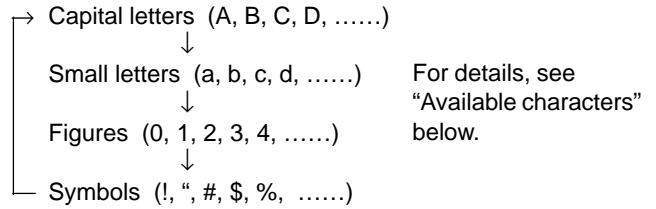

- A maximum of 12 characters can be used in each group name.

## Available characters

- Capital letters  
A B C D E F G H I J K L M N O P Q R S T U V W X Y Z
- Small letters  
a b c d e f g h i j k l m n o p q r s t u v w x y z
- Figures  
0 1 2 3 4 5 6 7 8 9

- Symbols  
! " # \$ % & ' ( ) \* + , - . / : ; < = > ? @ [ \ ] ^ \_ ` { | } ~ ■ ■ i  
 ç £ ¤ ¥ ¦ § ¨ © ª « ¬ ® ¯ ° ± ² ³ ´ µ ¶ · ¸ ¹ º » ¼ ½  
 ¾ ¿ À Á Â Ã Ä Å Æ Ç È É Ê Ë Ì Í Î Ï Ð Ñ Ò Ó Ô Õ Ö × Ø Ù  
 Ú Û Ü Ý Þ ß à á â ã ä å æ ç è é ê ë ì í î ï ð ñ ò ó ô õ ö ÷ ø ù  
 ú û ü ý þ ÿ (space)

## Display information during group edit (naming)

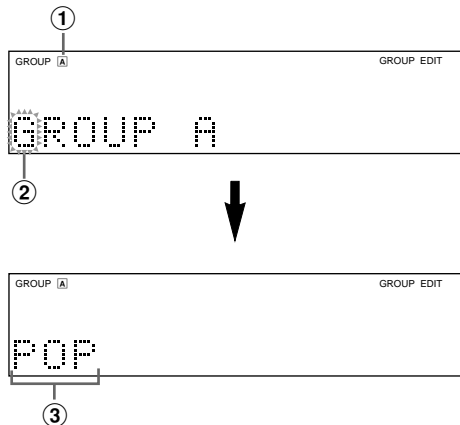

- ① Shows the selected group.
- ② Shows the cursor position.
- ③ Shows the group name you input.



# INDEX SEARCH

If the disc includes index numbers, play can be started from any desired index number.

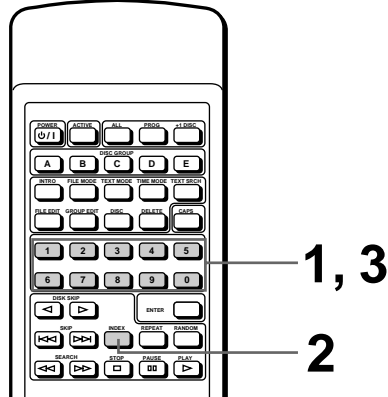

**1** Select a track which has index numbers.

1 2 3 4 5  
6 7 8 9 0

**2**

**3** Select the desired index number.

1 2 3 4 5  
6 7 8 9 0

ENTER

**To cancel the index search function**  
Press the **INDEX** button.

## Notes

- Not all discs have index numbers. The index system is a method for sub-dividing tracks into smaller divisions (for example, the movements within classical symphonies) for easier location of those parts. The liner notes with the disc usually tell if such index numbers are included.
- If an index number is selected that is higher than any index number on that disc, play will start from the last index number point on the disc.
- For some discs, play may begin slightly prior to the actual designated index point.
- If the disc has no encoded index points, play will begin from the start of the selected track.
- The index number can be designated only while "INDEX" appears in the display.

# INTRO SCAN

You can check the discs in the unit by listening to a short segment of each disc in turn. The unit will play several seconds segment from the second minutes of each disc. The unit scans discs in order of disc number from the current disc.

**1** Stop the unit.

**2**

## When the desired disc is located

During Intro scan, when the desired disc is located, press **INTRO** or **PLAY** to exit Intro scan and continue listening.

## To stop Intro scan

Press **STOP**.

## Note

- During program play mode, the unit scans all the discs in the unit.

# DISC FILING

## TEXT FILING

You can file each disc by album title and/or artist name in the unit's memory. You can easily locate a disc using the filed text data.

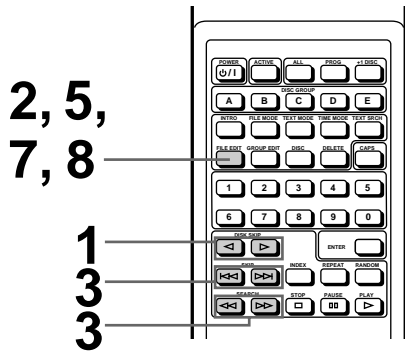

To input the album title and artist name for the selected disc

- 1 During stop, press **DISC SKIP** to select the disc to which you want to input the text data. (Make sure that "PROGRAM" indicator in the display is turned off before this step.)

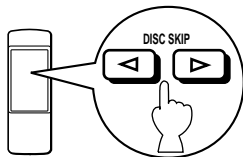

- 2 Press **FILE EDIT**.

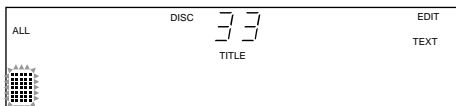

Cursor position

"TITLE" appears in the display and the cursor flashes. You can input the album title.

If you do not need to enter the album title, skip steps 3 and 4.

- 3 Press **SEARCH** or turn the JOG dial on the unit to select the character you want to input, then press **SKIP**. The cursor moves to next position.

Selected character

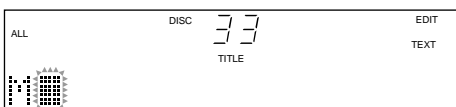
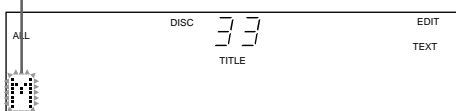

- 4 Repeat step 3 until the all characters you want are input.

- 5 Press **FILE EDIT** to store the album title.

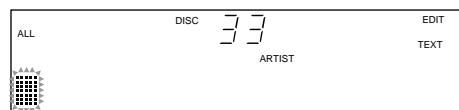
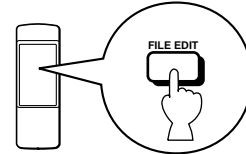

"ARTIST" appears in the display and the cursor flashes. You can input the artist name.

If you do not need to enter the artist name, skip step 6.

- 6 Repeat step 3 until the all characters you want are input.

- 7 Press **FILE EDIT** to store the artist name.

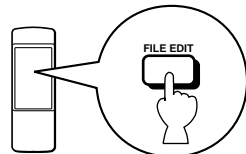

"BEST" appears in the display.

(For "BEST FILING" program, see page 20.)

- 8

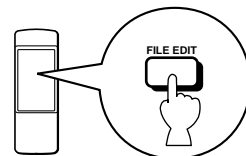

"SAVE" and "TEXT" appear in the display.

### Notes

- When you input a character, you can change the type of character by pressing **CAPS**. For details, see "Available characters" on page 16.
- A maximum 12 characters can be used in each album title or artist name.

## To correct the text data

1. In step 4 for "TITLE" or step 6 for "ARTIST" on the previous page, press **SKIP** to select the cursor position you want to correct.
2. Press **DELETE** to delete the character, or press **SEARCH** or turn the JOG dial on the front panel to select the new character.
3. Repeat the above step 2 until all corrections are completed.
4. Press **FILE EDIT**.

## To delete text data for a disc

1. Press **STANDBY/ON** on the front panel to turn off the unit.
2. Press **STANDBY/ON** and hold while simultaneously pressing **FILE MODE** and **DELETE**. Then, release **STANDBY/ON** first, then release **FILE MODE** and **DELETE**.
3. Press **SKIP** to select the disc you want to delete text data from.
4. Press **DELETE**.
5. Press **FILE EDIT**.

## CAUTIONS

- If you press **DELETE** for more than 5 seconds after step 2, "**DELETE**" appears for a moment, then "**ALL DELETE**" appears, and the entire contents of memory is erased. Be careful.
- Each disc file may contain up to 3 types of information:
  - album title
  - artist name
  - **BEST FILING** data.If you erase a disc file, all above information from that file will be erased.

## Note

- The unit's memory can hold information for about 200 discs. When the memory is full, "**MEMORY FULL**" appears in the display. To add more text data, you must first erase some unnecessary files from memory (you must erase all kinds of disc file data (album title, artist name, and **BEST FILING** data) for a disc).

## CD TEXT

This unit is compatible with the CD TEXT function. The CD TEXT disc has information, such as the album title, artist names, and track names. If the current disc is a CD TEXT disc, the unit captures the album title, artist name, and track names from the disc. You can easily locate a disc using the text data of a CD TEXT disc (see "To locate the disc by text data" on this page) and display the CD TEXT data (see "To display the text data" on this page).

## Notes

- The album title, artist names, or track names may not be displayed with some CD TEXT discs.
- You cannot change the CD TEXT data.

## To locate the disc by text data

- 1 During stop, press **TEXT SRCH** repeatedly until "SEARCH TITLE" (when you search for an album title) or "SEARCH ARTIST" (when you search for an artist name) appears in the display.

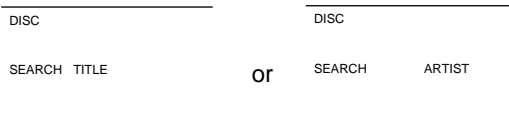

- 2 Press **SEARCH** or turn the JOG dial on the front panel to select the first character of the album title or the artist name you want to search for.



- 3

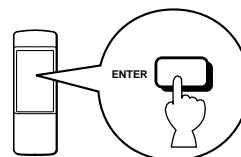

The unit locates all of the corresponding album titles or artist names beginning with the selected character and displays the first one according to slot number.

Press **SKIP** or turn the JOG dial on the front panel to advance to the next album title or artist name beginning with the selected character. Repeat until the desired album title or artist name is located.

- 4 Press **PLAY** to play the selected disc.

## To display the text data

Press **TEXT MODE**.

Each time you press **TEXT MODE**, the display changes as follows.

Album title → Artist name → Track name → Time display

- If no data is entered for the current disc (album title, artist name), "(NO ENTRY)" appears in the display.
- The track name is displayed only when the current disc is a CD TEXT disc and has the track name data.

## BEST FILING

It is possible to file only those tracks you want from each disc (i.e., hide unwanted tracks). You can easily play back the tracks in any order you set.

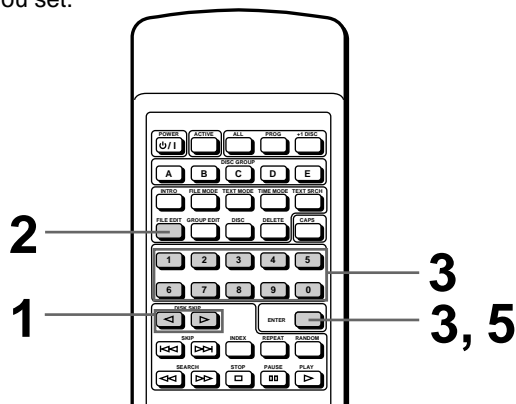

### Notes

- You can create as many as 32 edits for a each disc.
- If you input a track that the unit cannot accept, "ERROR" appears in the display.
- The unit's memory can hold information for about 200 discs. When the memory is full, "MEMORY FULL" appears in the display. To add more text data, you must first erase some unnecessary files from memory. See "To change program data" on this page.

### To play a disc with "BEST FILING" program

1. Press **STOP** to stop the unit.
2. Press **FILE MODE** so that "FILE" appears in the display. If "SAVE" and "BEST" appear in the display, the unit reads "BEST FILING" program.
3. Press **PLAY** to start playing.

### Notes

- If the disc does not have any "BEST FILING" program data in the memory, "BEST" does not appear in the display, and the unit does not perform the "BEST FILING" function.
- When the FILE indicator is illuminated in the display, you can play the filed data in random order by pressing **RANDOM**.

### To check "BEST FILING" program data

1. Press **STOP** to stop "BEST FILING" program play.
2. Press **FILE EDIT**.
3. Press **SKIP**  $\gg$ . Each time you press this button, the track number and the program number are displayed in the order of the program. When you want to check the preceding tracks, press **SKIP**  $\ll$ .

### To change "BEST FILING" program data

1. Follow the preceding procedure described in "To check "BEST FILING" program data."
2. Display the track number to be deleted or corrected by pressing **SKIP**.
3. Press the number button of the desired track you want to substitute for the one currently displayed. The previously programmed track will be cleared from the memory and the new one will be programmed. If you want to delete the programmed track currently displayed, press **DELETE**.
4. When you are finished, press **FILE EDIT**.

### To delete all discs "BEST FILING" program data

Press **DELETE** for more than 5 seconds after step 2 of the procedure described in "To delete text data" on page 19.

### CAUTION

**Deleting all discs "BEST FILING" program data will also erase the entire contents of memory (including album title or artist name). Be careful.**

### To input your favorite tracks

**1** During stop, press **DISC SKIP** to select the disc to which you want to edit.  
(Make sure that "PROGRAM" indicator in the display is turned off before this step.)

**2** Press **FILE EDIT** repeatedly until "BEST" appears in the display.

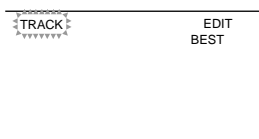

**3** Press the number button of the desired track, then press **ENTER**.

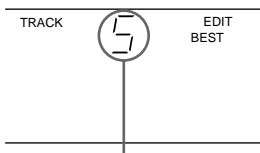

Selected track number

**4** Repeat steps 2 and 3 to program more tracks. You can select the same track again.

**5** Press **FILE EDIT** to store the text data. "SAVE" and "BEST" appear in the display.

# RELAY PLAY

If you have two CDM-900s, you can connect them and enjoy any combination play of 220 discs.

## Connections

**Never plug in these units or other components until all connections are completed.**

First, set the 2nd/MAIN switch of the unit connected to an amplifier to MAIN and the 2nd/MAIN switch of the other unit to 2nd. After completing the connections as shown below, connect the power cords of both units to the AC outlet.

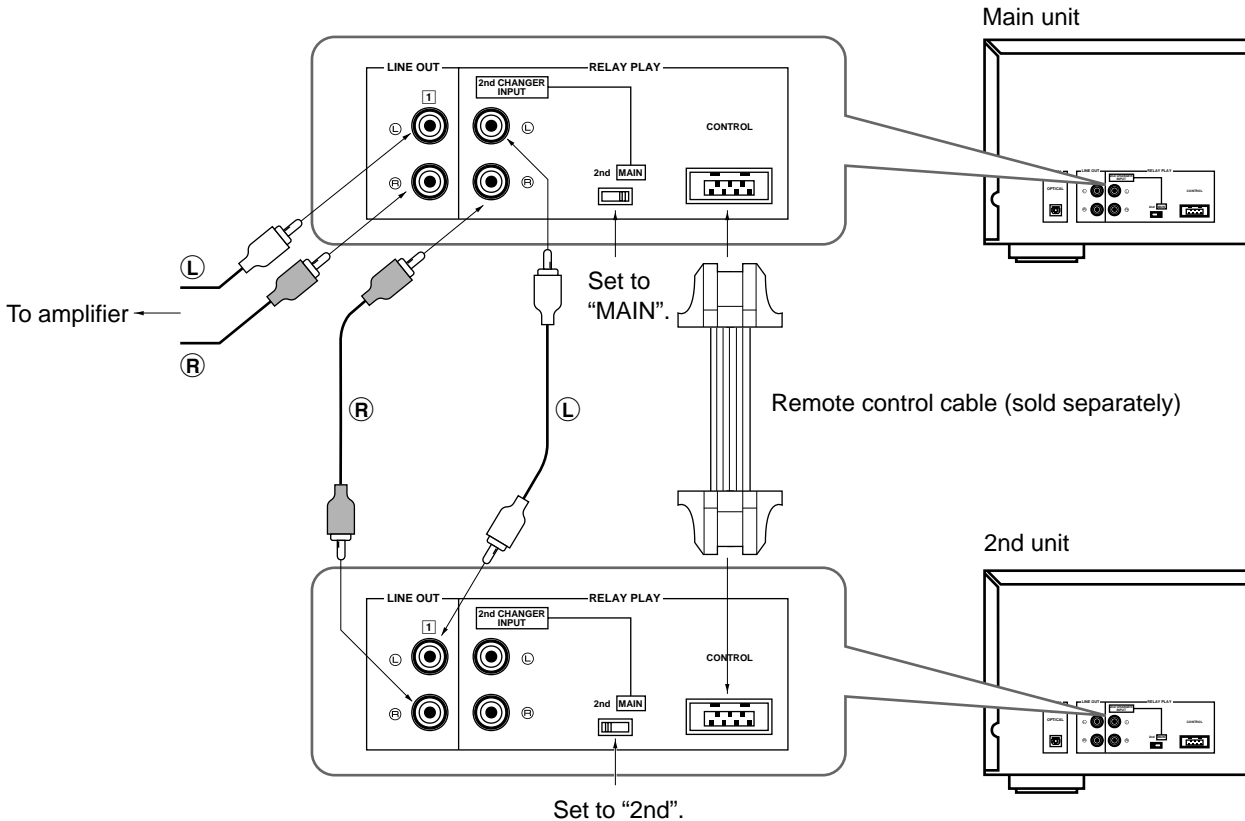

After completing the connections, press the STANDBY/ON buttons of both units to turn the power on. "ACTIVE" appears in the display of the main unit, "INACTIVE" appears in the display of the second unit. Relay play (switching between both units) takes effect according to the selected play mode.

### Notes

- The 2nd/MAIN switch should be set before plugging into the AC outlet.
- If relay play is not needed and each unit is used separately, the 2nd/MAIN switch on the rear panel of each unit should be set to the "MAIN" position.

## Disc play

If the power of both units is switched on, you can begin relay play. You can set play mode (ALL, GROUP, +1, PROGRAM) on each unit separately and enjoy any combination play using both units. First, the main (ACTIVE) unit starts play in the selected play mode, and Relay play will take effect according to the following chart (at which time the main unit will become "INACTIVE" and the second unit will become "ACTIVE") :

### When random sequence play mode of the ACTIVE unit is off

Playing mode of ACTIVE unit	ACTIVE unit and INACTIVE unit will switch when:
ALL	all discs finish playing.
GROUP	all discs of the group finish playing.
+1	the current disc finishes playing.
PROGRAM	all steps you programmed finish playing.

### When random sequence play mode of the ACTIVE unit is on

Playing mode of ACTIVE unit	ACTIVE unit and INACTIVE unit will switch when:
ALL	one track finishes playing.
GROUP	(In these cases, the INACTIVE unit enters random sequence play mode automatically.)
+1	

- When either unit is set to program play mode, the relay play function in random sequence play does not work.

**Example:** When you set the main unit to GROUP play mode and the second unit to +1 play mode.

- The main unit starts playing in group play mode.

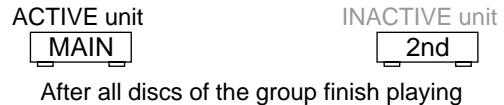

- The second unit becomes the ACTIVE unit and starts playing in +1 play mode

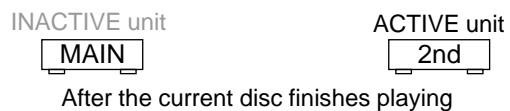

- The main unit becomes the ACTIVE unit again and starts playing in group play mode

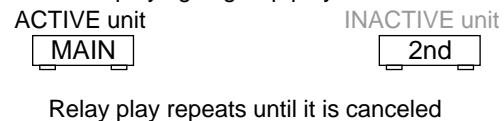

- The ACTIVE unit plays the BEST FILING program automatically if the current disc has BEST FILING data and "FILE" appears in the display.
- The remote control transmitter controls the ACTIVE unit only. To operate the INACTIVE unit, you must use the controls on the front panel.
- To switch the ACTIVE unit and INACTIVE unit manually, press **ACTIVE** on the remote control transmitter.

### To exit relay play mode

Turn either unit off. The other unit can still be used.

## TIMER PLAY

You can start play in any mode at any specified time by connecting a timer (sold separately). Refer also to the instructions for the timer.

1. Select the desired play mode (ALL, GROUP, +1, or PROGRAM).
2. Press **STANDBY/ON** to turn the unit off.
3. Press **STANDBY/ON** while pressing **PLAY** on the front panel.  
 Shortly thereafter, "TIMER P. ON" appears in the display and the timer play function is on.  
 (When the timer play function is already on, in which case, "TIMER P. OFF" appears in the display and timer play function is off. In this case, repeat the procedure in steps 2 and 3 to set the timer play function to on.)
4. Set the timer to the desired time.  
 When the set time comes, the unit turns on and starts play.

# NOTES ABOUT THE REMOTE CONTROL TRANSMITTER

## Battery installation

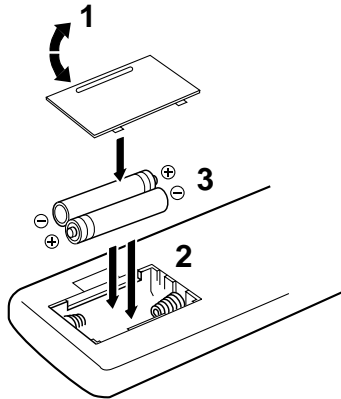

## Battery replacement

If you find that the remote control transmitter must be used closer to the main unit than usual, the batteries are weak. Replace both batteries with new ones.

## Notes

- Use only AA, R6, UM-3 batteries for replacement.
- Be sure the polarities are correct. (See the illustration inside the battery compartment.)
- Remove the batteries if the remote control transmitter will not be used for an extended period of time.
- If batteries leak, dispose of them immediately. Avoid touching the leaked material or letting it come in contact with clothing, etc. Clean the battery compartment thoroughly before installing new batteries.

## Remote control transmitter operation range

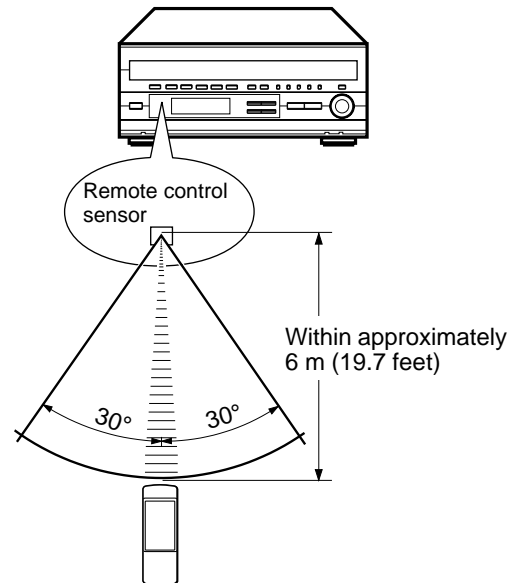

## Notes

- There should be no large obstacles between the remote control transmitter and the main unit.
- If the remote control sensor is directly illuminated by strong lighting (especially an inverter type of fluorescent lamp etc.), it might cause the remote control transmitter not to work correctly. In this case, reposition the main unit to avoid direct lighting.

# CD PREVENTIVE CARE

- This compact disc player is designed for playing compact discs bearing the  mark only. Never attempt to load any other type of disc into the unit. The unit cannot play 8-cm (3-inch) compact discs.
- Compact discs are not subjected to wear during play, but damage to the disc surface when the disc is being handled can adversely affect the disc's play.
- Do not use cleaning discs or warped discs. All of these could damage the unit.

## To prevent a malfunction of this unit

- Do not use any non standard shaped CD (heart etc.) available on the market, because it may damage the unit.

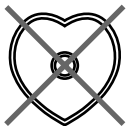

- Do not use a CD with tape, seals, or paste on it, because damage to the unit may result.

- Compact discs are not affected by small particles of dust or fingerprints on their playing surface, but even so they should be kept clean. Wipe by using a clean, dry cloth. Do not wipe with a circular motion; wipe straight outward from the center.

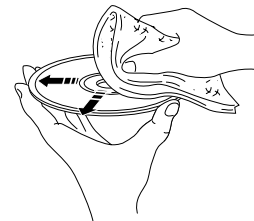

- Do not try to clean the disc's surface by using any type of disc cleaner, record spray, anti-static spray or liquid, or any other chemical-based liquid, because such substances might irreparably damage the disc's surface.

- Do not expose discs to direct sunlight, high temperature or high humidity for a long period of time, because these might warp or otherwise damage the disc.



# TROUBLESHOOTING

If the unit fails to operate normally, check the following points to determine whether the fault can be corrected by the simple measures suggested. If it cannot be corrected, or if the fault is not listed in the SYMPTOM column, disconnect the power cord and contact your authorized YAMAHA dealer or service center for help.

SYMPTOM	PROBABLE CAUSE	REMEDY
<b>The player does not switch ON when the STANDBY/ON switch or POWER button is pressed.</b>	The power cord is not connected or not completely connected.	Securely connect the power cord.
	Front panel is open.	Close the front panel securely.
<b>This unit does not work normally.</b>	There is an influence of strong external noise (lightning, excessive static electricity, etc.) or a misoperation was performed while using this unit.	Turn the power off and disconnect the AC power from the AC outlet. After about 30 seconds, connect the power and try again.
<b>Play does not begin.</b>	The disc is damaged.	Check the disc carefully; replace it if necessary.
	There is moisture on the laser pickup.	Wait 20 to 30 minutes after switching the unit ON before trying to play a disc.
	The disc has been loaded backwards.	Reload the disc with the label side facing right.
	The disc is dirty.	Clean the disc.
<b>Play is delayed, or begins at the wrong place.</b>	The disc may be scratched or damaged.	Check the disc carefully; replace it if necessary.
<b>No sound.</b>	Improper output cable connections.	Connect the cables properly. If the problem persists, the cables may be defective.
	Improper amplifier operation.	Set the amplifier controls to the correct input selection.
<b>Sound "skips."</b>	The player is being subjected to vibrations or impacts.	Relocate the player.
	The disc is dirty.	Clean the disc.
<b>Sound "hums."</b>	Improper cable connections.	Securely connect the audio cables. If the problem persists, the cables may be defective.
<b>Noise from a nearby tuner.</b>	The tuner is too close to the player.	Move the tuner and player farther apart.
<b>Noise from inside of the unit.</b>	The disc may be warped.	Replace the disc.
<b>"TAKE OUT" appears in the display.</b>	A disc is set in the slot of the disc being played.	Remove the disc from the currently playing disc's slot.
	The unit fail to work properly due to some external lighting or sound stimulus.	Open and close the front panel while the unit is turned on to reset the unit.
<b>The remote control transmitter does not work.</b>	The batteries of the remote control transmitter are too weak.	Replace the batteries with new ones.
	Direct sunlight or lighting (of an inverter type of fluorescent lamp etc.) is striking the remote control sensor of the main unit.	Change the position of the main unit.
	Front panel is open.	Close the front panel securely.



# SPECIFICATIONS

---

## AUDIO SECTION

Frequency response .....	2 Hz – 20 kHz, $\pm 0.5$ dB
Harmonic distortion + noise (1 kHz) .....	0.003% or less
S/N ratio .....	104 dB or more
Dynamic range .....	96 dB or more
Wow & flutter .....	Unmeasurable
Output level (1 kHz, 0 dB) .....	2.0 $\pm$ 0.5 V

## GENERAL

### Power requirements

U.S.A. and Canada models .....	120 V, 60 Hz
Australia model .....	240 V, 50 Hz
Europe and U.K. models .....	230 V, 50 Hz
General model .....	110/120/220/240 V, 50/60 Hz

Power consumption ..... 15 W

Dimensions (W  $\times$  H  $\times$  D) ..... 435  $\times$  176.5  $\times$  407.5 mm  
(17-1/4"  $\times$  7"  $\times$  16-1/8")

Weight ..... 8.4 kg (21 lbs. 3 oz)

Accessories ..... Connection cord  
Remote control transmitter  
Batteries (size AA, R6, UM-3)

Please note that all specifications are subject to change without notice.



---

**YAMAHA ELECTRONICS CORPORATION, USA** 6660 ORANGETHORPE AVE., BUENA PARK, CALIF. 90620, U.S.A.  
**YAMAHA CANADA MUSIC LTD.** 135 MILNER AVE., SCARBOROUGH, ONTARIO M1S 3R1, CANADA  
**YAMAHA ELECTRONIK EUROPA G.m.b.H.** SIEMENSSTR. 22-34, 25462 RELLINGEN BEI HAMBURG, F.R. OF GERMANY  
**YAMAHA ELECTRONIQUE FRANCE S.A.** RUE AMBROISE CROIZAT BP70 CROISSY-BEAUBOURG 77312 MARNE-LA-VALLEE CEDEX02, FRANCE  
**YAMAHA ELECTRONICS (UK) LTD.** YAMAHA HOUSE, 200 RICKMANSWORTH ROAD WATFORD, HERTS WD1 7JS, ENGLAND  
**YAMAHA SCANDINAVIA A.B.** J A WETTERGRENS GATA 1, BOX 30053, 400 43 VÄSTRA FRÖLUNDA, SWEDEN  
**YAMAHA MUSIC AUSTRALIA PTY, LTD.** 17-33 MARKET ST., SOUTH MELBOURNE, 3205 VIC., AUSTRALIA

**YAMAHA CORPORATION**  
Printed in Malaysia (YP) V276350